

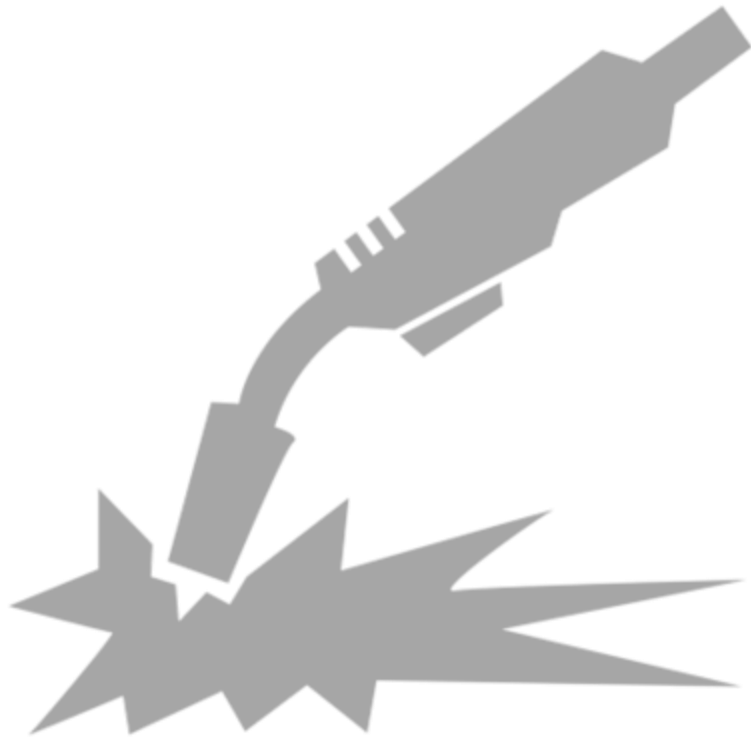

**MTG**

No limits innovation



**GEN.3.3.1**  
**GENERAL WELDING**  
**RECOMENDATIONS**

**NOTE:** This “welding guide” is intended to assist customers with welding GET products. It is a general welding guide and is not all inclusive. Your specific application may require different welding practices. This welding guide is not intended to be used for joint design of buckets or other attachments. MTG accepts no responsibility for the misuse or misinterpretation of this information.



## 1. PROCESSES

Welding may be done by any of the following processes:

**Shielded metal arc welding (SMAW)**

**Gas-metal arc welding (GMAW)**

**Flux-cored arc welding (FCAW)**

A combination of SMAW, GMAW, and FCAW can be utilized.

## 2. CONSUMABLES

### 2.1 WELDING UNALLOYED AND LOW ALLOYED CONSUMABLES

Unalloyed and low-alloyed consumables with tensile strength up to 500 MPa should be used. Such welding consumables reduce the residual stress level in the joints and thus the susceptibility to hydrogen induced cracking.

#### WELDING UNALLOYED & LOW ALLOYED FILLER CONSUMABLES

PROCESS	EN CLASS	AWS CLASS
<b>SMAW</b>	EN ISO 2560-A E42X	E70X ACCORDING TO A5.1 OR EQUIVALENT UNDER A5.5
<b>GMAW</b>	EN ISO 14341-A G42X	E70C-X ACCORDING TO A5.18 OR EQUIVALENT UNDER A5.28
	EN ISO 14341-A G46X	E70S-X ACCORDING TO A5.18 OR EQUIVALENT UNDER A5.28
<b>FCAW</b>	EN ISO 16834-A T42X	E7XT-X ACCORDING TO A5.20 OR EQUIVALENT UNDER A5.29

NOTE: “X” MAY STAND FOR ONE OR SEVERAL CHARACTERS

### 2.2 WELDING AUSTENITIC STAINLESS CONSUMABLES

All MTG GET casting parts can always be welded with austenitic stainless consumables of type AWS 307. Designation for such consumables as per following:

**WELDING AUSTENITIC STAINLESS FILLER CONSUMABLES**

PROCESS	AWS CLASS
SMAW	E307-X ACCORDING TO A5.4
	E307T-X ACCORDING TO A5.22
GMAW	ER307 ACCORDING TO A5.9
FCAW	307-X ACCORDING TO A5.22

NOTE: "X" MAY STAND FOR ONE OR SEVERAL CHARACTERS

### 2.3 SHIELDING GAS CONSIDERATIONS

For shielding gas considerations, refer to the welding consumable manufacturer information. When a gas or mixture is used for shielding in any gas-shielded process, it shall meet the requirements of AWS A5.32/5.32M, "Specification for Welding Shielding Gases".

### 2.4 HYDROGEN CONTENT CONSIDERATIONS

If welding with SMAW or FCAW, basic flux electrodes should be used verify that the hydrogen content is less than 5ml/100g of weld metal.

## 3. ELECTRICAL CHARACTERISTICS

Welding shall be done using the following electrical characteristics:

### 3.1 POLARITY

All welding shall be done using direct current reverse electrode positive (D.C.E.P.) except for GTAW weld toe dressing, which shall be done using direct current electrode negative (D.C.E.N).

### 3.2 CURRENT AND VOLTAGE RANGES

Below, in the following chart, the recommended current and voltages ranges for a specific process and electrode diameter.

**SMAW**

ELECTRODE DIAMETER	CURRENT (AMPERES)
2.4m m / 3/32in.	65 – 120
3.2m m / 1/8in.	80 – 160
4.0m m / 5/32in.	115 – 220
4.8m m / 3/16in.	140 – 300
6.4m m / 1/4in.	230 - 375

**GMAW & FCAW**

ELECTRODE DIAMETER	VOLTAGE(VOLTS)	CURRENT (AMPERES)
1.14mm / 0.045in.	22 – 30	220 – 320
1.59mm / 1/16in.	25 – 35	250 – 360
2.4mm / 3/32in.	25 - 35	360 - 500

### 3.3 HEAT INPUT CONSIDERATIONS

Minimum heat input to be applied shall meet the requirements of AWS D14.8M, “Standard Methods for the Avoidance of Cold Cracks”.

As reference, typical heat input values to be applied lie in the range from 1 kJ/mm to 2 kJ/mm targeting 1.5kJ/mm.

## 4. POSITION

All welding is to be done preferably on the flat or horizontal position. Deviation from the flat or horizontal position is permissible following the figure shown below which is adapted from AWS D14.3, Specification for Welding Earthmoving and Construction Equipment.

Longitudinal axis of weld may be inclined no more than 15° with respect to the horizontal plane.

Centre of weld face (C) must lie within rotational limits of 80° to 280° as indicated.

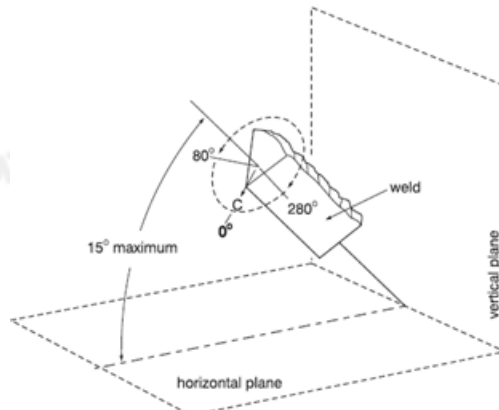

## 5. PREPARATION OF PLATE AND CASTINGS

### 5.1 CLEANING

All mill scale, rust, paint, oil grease, arc air slag, or moisture shall be removed from the surfaces within 12.5 mm - 0.5 in. of any weld location. The surfaces must be sufficiently clean so that there is nothing that might contain moisture or hydrocarbons, which break down in the heat of the arc producing hydrogen, which can be absorbed in the weld causing cracks.

Removal may be accomplished by shot blasting, sand blasting, grinding, or machining. Any porosity, burned-in sand or other defects visible on the weld prep surfaces must be removed by grinding or arc air gouging.

## 6. PREHEAT, INTERPASS TEMPERATURES AND POST WELD HEAT TREATMENT

### 6.1 TEMPERATURES

Prior to any cutting, gouging, or welding operation, preheating of GET casting parts and lips is required. All material within 100mm - 4 in. from the welding location must be within the specified temperature range before starting a weld bead.

The minimum preheating temperature to be applied is 175°C - 347°F or the temperature recommended by the lip manufacturer if it is higher than 175°C - 347°F. To maintain GET castings hardness, temperatures exceeding 250°C - 482°F are not advised.

If the ambient humidity is high and/or the room temperature is below 5°C - 41°F, the preheating temperature should be increased by 25°C - 77°F, this is 200°C – 392°F.

Use insulating blankets at all time. If the pre-heating or the welding process is interrupted for any reason (on a shift change i.e.) the area already warm or being heated should be covered with thermal blankets.

### 6.2 PREHEATERS

Preheating with burners or torches is much more effective when the heat is applied from the opposite side of the work piece while having insulating blankets on the work side. The blankets help to disperse the heat evenly and retain the heat that has been input.

### 6.3 MEASUREMENT

Temperatures may be measured by using contact pyrometers, temperature indicating crayons (e.g. "Tempilsticks"), or infrared indicators.

Maximum interpass temperature can be directly measured in the weld metal or in the immediately adjacent area.

## 6.4 COOL DOWN RATES

After welding completion, cool down slowly. Do not allow drafts or cold ambient temperatures to cool the parts or assembly down. Cool down rate should not exceed 55°C - 131°F per hour. If the ambient temperature is at or below 5°C - 41°F, or if the indicated cool down rate can not be achieved, the part should be covered in thermal blankets to insure a slow cool down.

## 6.5 POST WELD HEAT TREATMENT

As an optional treatment, after welding completion and whenever possible, a post weld heat treatment is a good practice for tempering the entire part. A post-heating of 200°C – 392°F for at least 2 hours (once the temperature has been reached) and then air cooled should be enough for that purpose.

# 7. WELDING TECHNIQUE

## 7.1 WELDING

Prior to welding clean the surfaces according to procedure detailed in Section “Cleaning”. Welds shall consist preferably of stringer beads. However, weaving is permitted to extend that bead. Widths must be no greater than three times the electrode diameter. Each bead shall merge smoothly into the adjoining bead or base metal surface.

Clean each pass of deposited weld metal before applying an adjoining pass. Cleaning may be accomplished using manual slag hammers, pneumatic needle guns, wire brushes, or any combination of these tools.

**NOTE:** Under normal conditions, it is a good idea to put root layers and several weld layers when using the SMAW Welding Process and E7018 electrodes that have been kept dry in a rod oven according to the producer specifications. If this info is not available keep them in a rod oven from 65°C to 150°C - 150°F to 302°F for two hours, then use the GMAW or FCAW Welding Processes. This helps reduce heat input in the thin root layer sections of the weld joint.

Do not weld within 19mm to 25mm – 3/4 in. to 1 in. of any lip leading edge.

## 7.2 WELDING STOPPING

When the ends of weld beads are located within the finished product, the welder shall execute an appropriate stopping procedure to avoid crater cracks.

When welding with the SMAW process, the simplest method for accomplishing this is to stop travel for a short time at the end of the bead prior to breaking the arc. Alternatively, the travel direction may be reversed for approximately 10mm - 3/8 in. before breaking the arc.

When welding with the FCAW or GMAW processes, it is preferable to briefly extinguish the arc, initiate it for a short time, and then extinguish it again.

## 8. WELDING FINISHING

To improve resistance to hydrogen assisted cracking and fatigue cracking, one or more weld finishing techniques may be used. These finishing techniques are oriented to improve the geometry of the weld toe and to modify the residual stress after welding.

The techniques oriented to improve the geometry includes grinding and GTAW (TIG) dressing.

The ones oriented to modify the residual stress after welding includes weld toe peening, and High frequency mechanical impact (HFMI)

### WELDING FINISHING TECHNIQUES

METHOD	WELD GEOMETRY IMPROVEMENTS		MECHANICAL EFFECTS
	INCREASING AND SMOOTHING TRANSITION	ELEMINATES DEFECTS	INDUCES COMPRESSIVE RESIDUAL STRESSES
GRINDING	X	X	-
TIG DRESSING	X	X	-
NEEDLE PEENING	X	X	X
HFMI	X	X	X

It is also important to minimize the effects of the heat affected zone for castings. To do so, it is highly recommendable the application of temper beads.

As a minimum, all castings welds shall be ground, and it is also recommendable a Weld Toe Peening or a GTAW (TIG) process.

### 8.1 GRINDING

The surfaces of adapter/lip fabrication welds shall be ground smooth 65mm to 75mm - 2½ in. to 3 in. from the front ends as indicated in the figures below. All welds on both, the top and bottom of the lip shall be grounded.

Grinding shall produce a smooth surface free of roughness and unevenness associated with the weld beads. The toes of the welds shall merge smoothly with the lip and the adapter with a minimum radius of 4mm - 5/32 in.

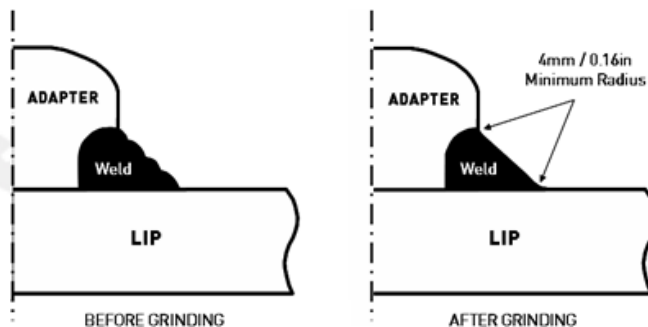

Grinding shall be done using high speed electric or pneumatic grinders with grinding wheels no larger than 50mm - 2 in. in diameter. ANGLE HEAD OR DISK GRINDERS ARE NOT ALLOWED FOR THIS WORK.

Grinding shall be done with the perimeter of the wheel and not the face. The grinding direction must be perpendicular to the toes of the welds as it is described in the following illustration:

Proper Grinding Direction:

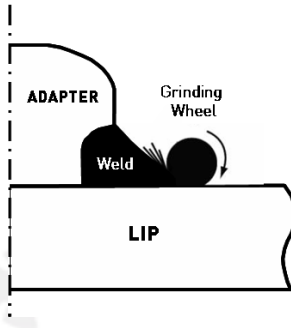

Grinding the radius at the toes of the welds is facilitated using cone-shaped grinding wheels. For final grinding, the abrasive may be no coarser than 24 Grit.

## 8.2 GTAW (TIG) DRESSING

This process involves using a GTAW torch to make an autogenous weld pass along the toe of the weld fillet.

The welding power supply shall have high-frequency start capabilities. "Scratch-starting" is not allowed. It is preferable to employ a remote foot-pedal current control to permit suitable filling of craters at the ends of the beads.

### GTAW

PROCESS	GTAW	
ELECTRODE TYPE	AWS EWTh-2 (2% THORIATED)	
ELECTRODE DIA.	2.4mm to 4.0 mm / 3/32 to 5/32in.	
SHIELDING GAS	100% ARGON	
GAS CAP SIZE	13mm / 0.50in.	
GAS FLOWRATE	9.4 to 14.2 l/minute / 20 to 30 ftV/hour	
CURRENT SIZE	DIRECT	
POLARITY	STRAIGHT (ELECTRODE NEGATIVE)	
CURRENT RANGE	2.4mm / 3/32in.	175 to 250 AMPERES
	3.2mm / 1/8in.	250 to 300 AMPERES
	4.0mm / 5/32in.	400 to 500 AMPERES
ELECTRODE TO WORK DISTANCE	1.6mm to 3.2 mm / 1/16 to 3/32in.	



Any defects along the toes of the welds must be corrected by grinding or welding repair before the GTAW process. The torch shall be positioned over the weld toe and shall be oriented to produce a smooth weld bead without undercut. The welder shall control the travel speed to obtain a bead ranging from 4.8mm to 8mm - 3/16 in. to 5/16 in. wide.

The GTAW dressing is recommendable to be performed along the weld toes on the top and bottom legs according to the next figure.

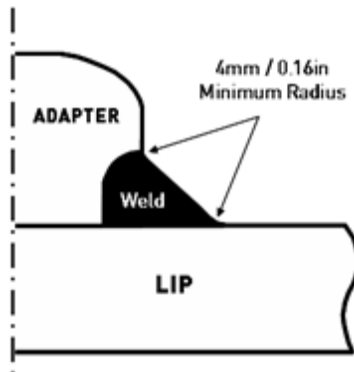

### 8.3 WELD TO PEENING

Certain welds may be required by the drawing be subjected to Weld Toe Peening. This is to be conducted using a pneumatic hammer having the following specifications:

Pneumatic Peening Gun Specifications:

#### PNEUMATIC PEENING GUN SPECIFICATIONS

AIR PRESSURE	AIR CONSUMPTION	STROKE LENGHT	BLOWS PER MINUTE
6.2 bar / 90 psi	340 l/minute / 12ft <sup>3</sup> /minute	32mm / 1.13in	4600

Peening tools shall be made of hardened tool steel, with the tip hardness of at least HRc55. The tips shall be carefully radius to eliminate all corners and shall be polished to a fine finish. To preserve the tip geometry and finish, these tools are to be used strictly for weld toe peening and no other purpose. Any marked changes in tip geometry or finish due to wear requires the tip to be re-ground and polished.

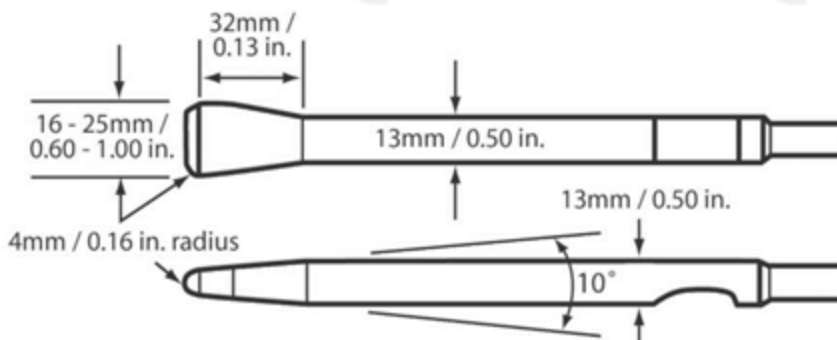

Any defects or pronounced undercut along the toes of the welds must be corrected by grinding or repair welding before the peening process.

During peening, the temperature of the work piece must be below 200°C - 400°F. The peening tool shall be held firmly against the toe of the weld such that the edge of the bit lies along the toe of the weld.

The tool shall be oriented at an angle approximately bisecting that formed by the weld fillet and the base metal. The operator shall move the tool slowly 200mm to 300mm - 8 in. to 12 in. per minute along the toe of the weld to produce a smooth, continuous groove of 0.4mm to 0.8mm - 1/64 in. to 1/32 in. deep.

## 8.4 HIGH FREQUENCY MECHANICAL IMPACT (HFMI)

The purpose of the HFMI is to create a depression of 0.5mm - 1/50 in. along the weld toe and it is made with compressive forces. This depression should be created at the weld toe of the welding to the plate and the welding to the casting (adapter). The depression's length should be indicated on the specific welding instructions of each item which requires it.

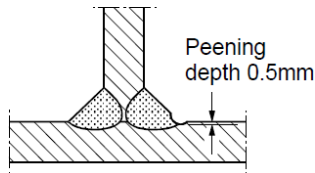

For the HFMI, one of the following devices should be used:

HFMI

### DEVICES

Ultrasonic impact treatment (UIT)

Ultrasonic peening (UP)

Ultrasonic peening treatment (UPT)

Ultrasonic needle peening (UNP)

Pneumatic impact treatment (PIT)

High frequency impact treatment (HiFIT)

Whatever which frequency >90Hz





Regarding the indenters that need to be used, they should not be greater than 12mm - 1/2 in. of diameter as bigger sizes will not treat the weld toe and can deform the welding and create potential cracks.

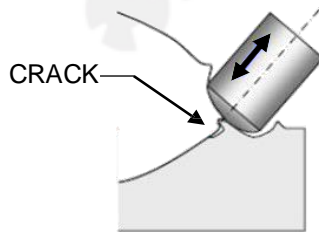

Effective treatment requires reasonably accurate positioning of the tool's tip over the weld toe so that metal on each side (both weld metal and parent plate) is deformed. This will normally be achieved by supporting the hammer firmly and keeping the peening tool's tip in close contact with the weld toe as it is moved along the weld. The hammer should be held at about 45° to the plate surface and approximately perpendicular to the direction of travel, as shown in the figure below.

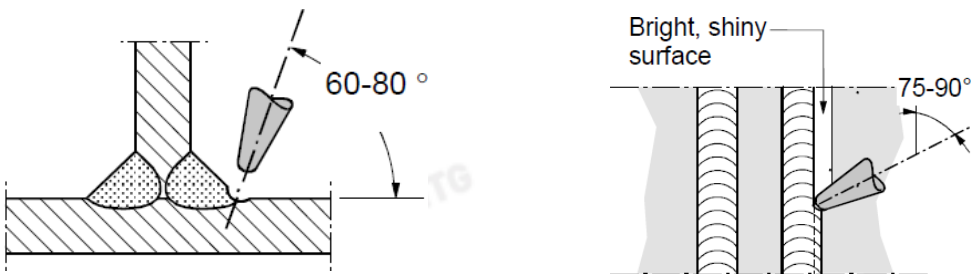

The resulting groove must be smooth and free from obvious individual indentations, as illustrated in the figure below. The travel speed will depend to some extent on access and hammer peening position, but also on the equipment used.

A hammer gun which is heavy and vibrates will cause the tool to jump along the weld, missing some areas. Repeated peening, usually four passes, is then needed to achieve full coverage and a smooth surface. Lighter, vibration-damped hammer guns facilitate slower travel speeds, and hence more thorough treatment per pass.

A travel speed of 50mm/min to 100 mm/min - 2 in/min to 4 in/min, similar to typical welding speeds, should be aimed for when the required depth is achieved in one pass.

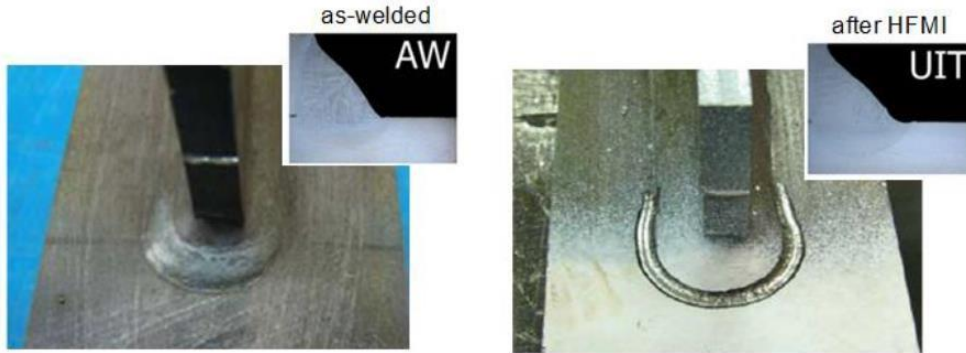

## 8.5 TEMPERING BEADS

A tempering or annealing bead is an additional weld pass that is added to the weldment once the weld joint is completely filled. This extra weld pass is used in all weld joints that weld is deposited against the heat-treated steel castings.

The heat of this weld pass tempers or anneals the final weld pass against the casting and the heat affected zone (HAZ) within the casting caused by the weld pass adjacent to the casting.

This weld pass should be deposited from 3mm to 5mm - 1/8 in. to 3/16 in. away from the final weld pass against the casting as the following picture shows.

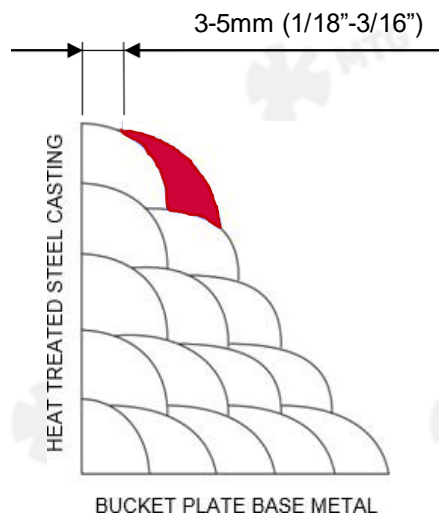

## 9. INSPECTION

After completion of welding, all welds shall be subjected to visual and magnetic particle inspection.



## Service Instructions

The latest welding recommendations and assembly / disassembly instructions can be found online:

[www.mtgcorp.com/manuals](http://www.mtgcorp.com/manuals)

Please contact Technical Services in case of questions:

[technical.services@mtg.es](mailto:technical.services@mtg.es)



---

### MTG HEADQUARTERS

Carrer d'Àvila, 45  
08005 Barcelona (Spain)  
(+34) 93 741 70 00  
info@mtg.es

### MTG NORTH AMERICA

4740 Consulate Plaza Drive  
Houston, TX 77032 (USA)  
+1 (281) 872 1500  
info@mtgcorp.us

### MTG AUSTRALIA

16 – 18 Thorpe Close  
Welshpool, WA, 6106 (AUS)  
+61 8 6248 6513  
Info.australia@mtg.es